

Samson

Recessed spotlight adjustable with trim
Ref. | 1022

Samson | 1022



Description

Housing

Material | Aluminium
Mounting | Ceiling Recessed
Adjustability | Tilt 0° to 50° and rotation 350°
Protection indice | IP20
Safety line | L 1000mm
Finishing | White powder RAL 9003 / Black powder RAL 9005 / Other available on request

Light source

Light source | LED
Initial chromaticity | 2 SDCM / 3 SDCM
Colour rendering index | CRI>80 / CRI>90 / CRI>95 / CRI>97
Colour temperature | 2700K / 3000K / 3500K / 4000K
Lumen maintenance | Ta 25°C L90/B10 50000h

Driver

External - Connected | No dimmable On-Off / Dimmable (Dali, 1-10V)
Protection indice | IP20
Input voltage | 220 to 240V
Input frequency | 50Hz/60Hz
Power factor | 0,9
Driver lifespan | 5000 h: 1%
Range of operating temperatures | +10°C to +40°C
Average ambient temperature | +25°C
Power | 28W 700mA / 35W 900mA

Optic

Optical type | Lens (15°, 24°, 36°)
Light distribution | Symmetric

Luminous flux

Luminous flux tolerance | +/- 10%

28W 700mA	3000K, CRI>97, 2597lm
	4000K, CRI>97, 2795lm
35W 900mA	3000K, CRI>97, 3194lm
	4000K, CRI>97, 3309lm

Accessories and options on request

Fast connector

Conformity

European technical standard EN60598-1 and annexes.

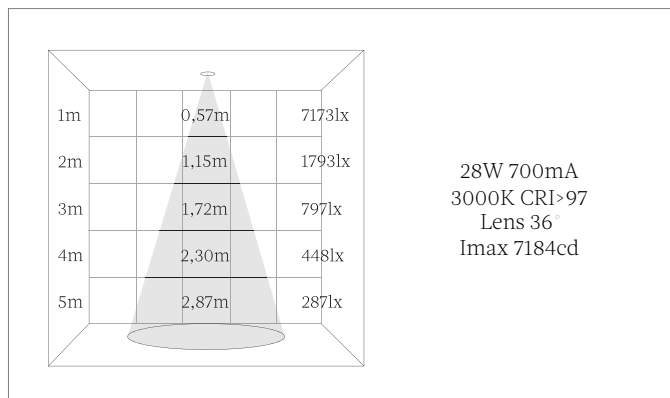
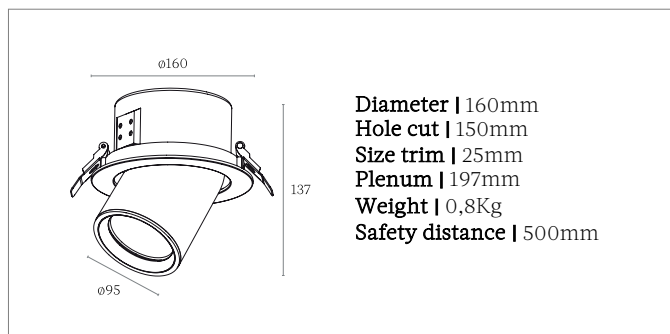

Contact

20, rue de Tournon 75006 Paris, France
 Phone: +33(0)1 43 54 00 55
 Email: bonjour@marlone.co
www.marlone.co



Downloads and product information

Product page: <https://marlone.co/produits/samson-1022/>