

Samson

Tracklight
Ref. | 4142

Samson | 4142



Description

Housing

Material | Aluminium

Mounting | Track 3-phase Nordic Aluminium

Adjustability | Tilt 0° to 90° and rotation 350°

Protection indice | IP20

Finishing | White powder RAL 9003 / Black powder RAL 9005 / Other available on request

Light source

Light source | LED

Initial chromaticity | 2 SDCM / 3 SDCM

Colour rendering index | CRI>80 / CRI>90 / CRI>95 / CRI>97

Colour temperature | 2700K / 3000K / 3500K / 4000K

Lumen maintenance | Ta 25°C L90/B10 50000h

Driver

Integrated | No dimmable On-Off

Input voltage | 220 to 240V

Input frequency | 50Hz/60Hz

Power factor | 0,9

Driver lifespan | 5000 h: 1%

Range of operating temperatures | +10°C to +40°C

Average ambient temperature | +25°C

Power | 24W 600mA / 28W 700mA / 35W 900mA

Optic

Optical type | Lens (15°, 24°, 36°)

Light distribution | Symmetric

Luminous flux

Luminous flux tolerance | +/- 10%

28W 700mA 3000K, CRI>97, 2597lm
4000K, CRI>97, 2795lm

35W 900mA 3000K, CRI>97, 3194lm
4000K, CRI>97, 3309lm

Conformity

European technical standard EN60598-1 and annexes.

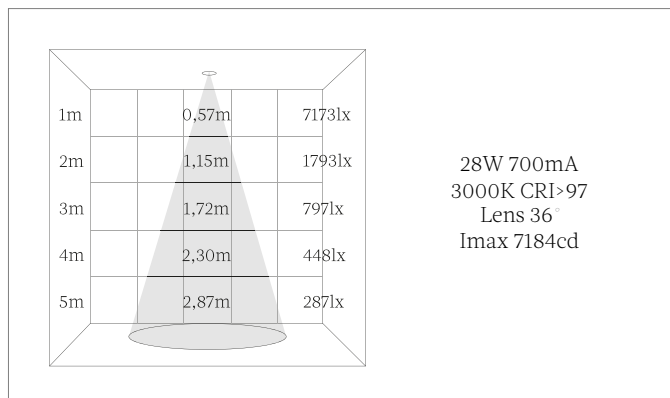
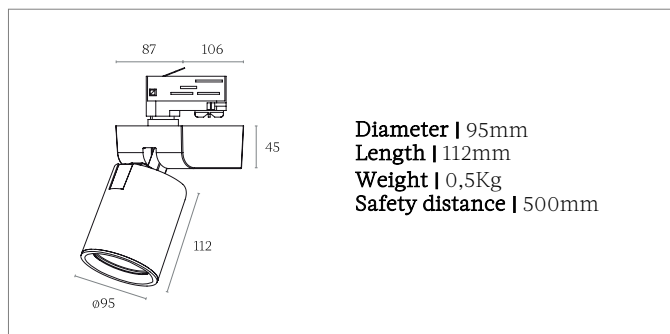

Contact

20, rue de Tournon 75006 Paris, France
Phone: +33(0)1 43 54 00 55
Email: bonjour@marlone.co
www.marlone.co



Downloads and product information

Product page: <https://marlone.co/produits/samson-4142/>