

Gabriel

48V Tracklight
Ref | 8122

Gabriel | 8122



Description

Housing

Material | Aluminium

Mounting | 48V Track

Adjustability | Tilt 0° to 90° and rotation 350°

Protection indice | IP20

Finishing | White powder RAL 9003 / Black powder RAL 9005 / Other available on request

Light source

Light source | LED

Initial chromaticity | 2 SDCM / 3 SDCM

Colour rendering index | CRI>80 / CRI>90 / CRI>95 / CRI>97

Colour temperature | 2700K / 3000K / 3500K / 4000K

Lumen maintenance | Ta 25 C L90/B10 50000h

Driver

Integrated to the rail adapter | No dimmable On-Off / Dimmable (Dali)

Input voltage | 48V

Driver lifespan | 5000 h: 1%

Range of operating temperatures | +10 C to +40 C

Average ambient temperature | +25 C

Power | 10W 250mA

Optic

Optical type | Lens (15°, 24°, 36°)

Light distribution | Symmetric

Luminous flux

Luminous flux tolerance | +/- 10%

10W 250mA 2700K, CRI>97, 721lm

3000K, CRI>97, 742lm

4000K, CRI>97, 786lm

Accessories and options on request

Honeycomb

Filters

Arm length (26mm, 50mm)

Tunable white

Conformity

European technical standard EN60598-1 and annexes.

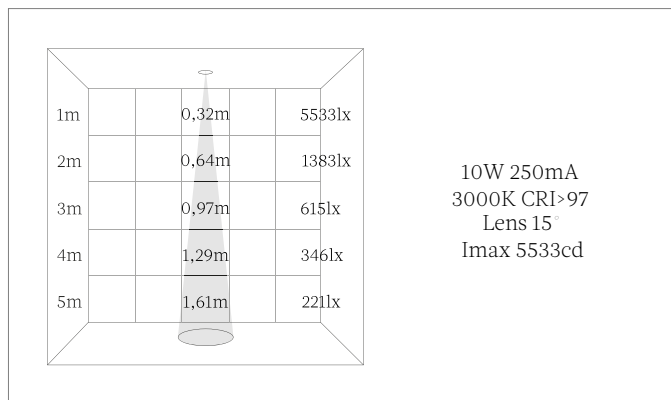
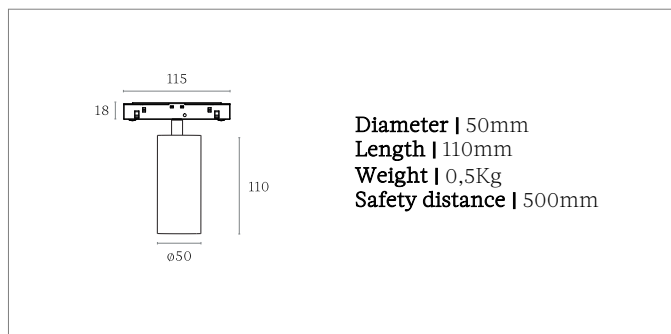

Contact

Phone: +33(0)1 47 48 10 64
Email: bonjour@marlone.co
www.marlone.co



Downloads and product information

Product page: <https://marlone.co/produits/gabriel-8122-3/>