

# Gabriel

Tracklight  
Ref. | 8122

Gabriel | 8122



## Description

### Housing

**Material** | Aluminium

**Mounting** | Track 3-phase Nordic Aluminium

**Adjustability** | Tilt 0° to 90° and rotation 350°

**Protection indice** | IP20

**Finishing** | White powder RAL 9003 / Black powder RAL 9005 / Other available on request

### Light source

**Light source** | LED

**Initial chromaticity** | 2 SDCM / 3 SDCM

**Colour rendering index** | CRI>80 / CRI>90 / CRI>95 / CRI>97

**Colour temperature** | 2700K / 3000K / 3500K / 4000K

**Lumen maintenance** | Ta 25 C L90/B10 50000h

### Driver

**Integrated to the rail adapter** | No dimmable On-Off / Dimmable (Triac, Dali, 1-10V)

**Input voltage** | 220 to 240V

**Input frequency** | 50Hz/60Hz

**Power factor** | 0,9

**Driver lifespan** | 5000 h: 1%

**Range of operating temperatures** | +10 C to +40 C

**Average ambient temperature** | +25 C

**Power** | 10W 250mA

### Optic

**Optical type** | Lens (15°, 24°, 36°)

**Light distribution** | Symmetric

### Luminous flux

**Luminous flux tolerance** | +/- 10%

10W 250mA      2700K, CRI>97, 721lm  
                          3000K, CRI>97, 742lm  
                          4000K, CRI>97, 786lm

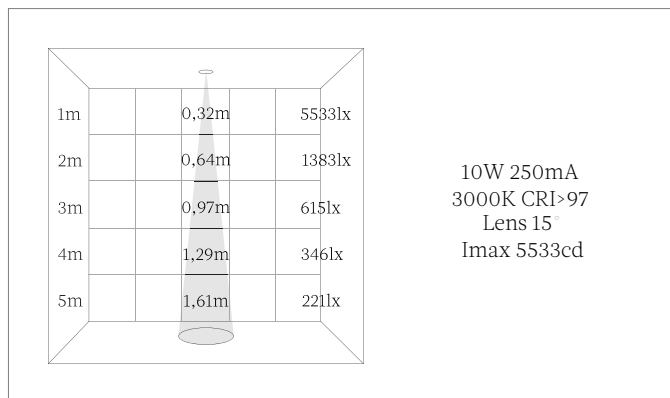
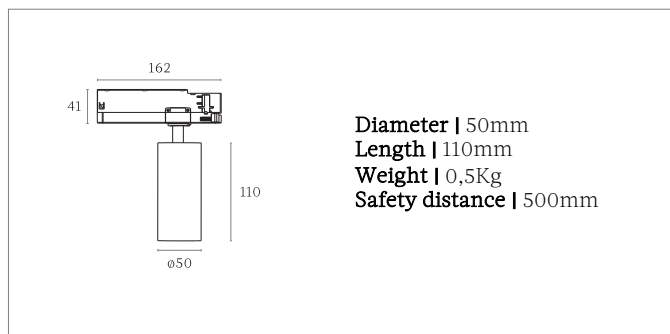

### Accessories and options on request

Arm length (26mm, 50mm)  
 Dim button on track adapter  
 Honey comb  
 Filter  
 Tunable white

### Conformity

European technical standard EN60598-1 and annexes.

### Contact

Phone: +33(0)1 47 48 10 64  
 Email: [bonjour@marlone.co](mailto:bonjour@marlone.co)  
[www.marlone.co](http://www.marlone.co)



### Downloads and product information

Product page: <https://marlone.co/produits/gabriel-8122-4/>