

Gabriel

Surface spotlight
Ref | 8124

Gabriel | 8124



Description

Housing

Material | Aluminium

Mounting | Ceiling Surface

Adjustability | Tilt 0° to 90° and rotation 350°

Protection indice | IP20

Finishing | White powder RAL 9003 / Black powder RAL 9005 / Other available on request

Light source

Light source | LED

Initial chromaticity | 2 SDCM / 3 SDCM

Colour rendering index | CRI>80 / CRI>90 / CRI>95 / CRI>97

Colour temperature | 2700K / 3000K / 3500K / 4000K

Lumen maintenance | Ta 25 C L90/B10 50000h

Driver

External - Connected | No dimmable On-Off / Dimmable (Dali, Triac, 1-10V)

Protection indice | IP20

Input voltage | 220 to 240V

Input frequency | 50Hz/60Hz

Power factor | 0,9

Driver lifespan | 5000 h: 1%

Range of operating temperatures | +10 C to +40 C

Average ambient temperature | +25 C

Power | 20W 500mA

Optic

Optical type | Lens (15°, 24°, 36°)

Light distribution | Symmetric

Luminous flux

Luminous flux tolerance | +/- 10%

20W 500mA 2700K, CRI>97, 1307lm

3000K, CRI>97, 1359lm

4000K, CRI>97, 1421lm

Accessories and options on request

Honeycomb

Filters

Base ø50mm and h. 20mm

Base ø75mm and h. 35mm

Arm length (26mm, 50mm)

Tunable white

Fast connector

Conformity

European technical standard EN60598-1 and annexes.

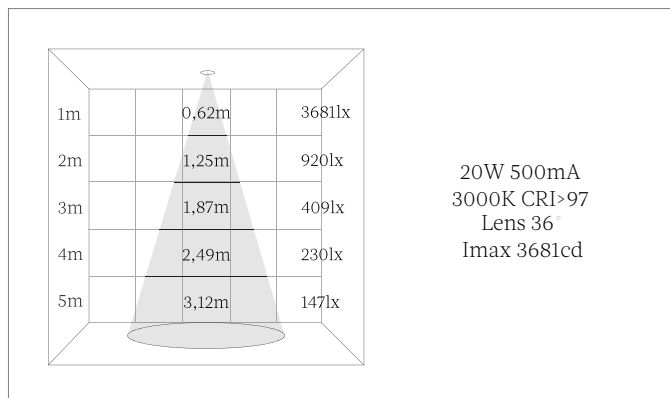
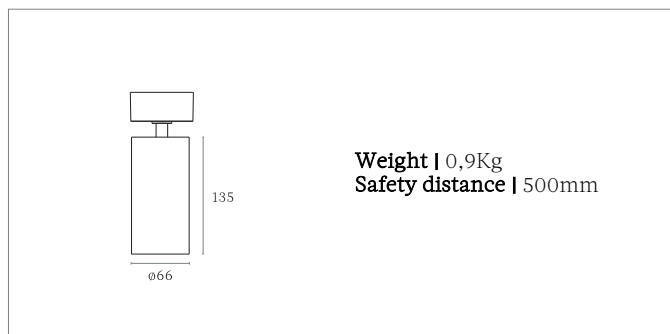

Contact

Phone: +33(0)1 47 48 10 64
Email: bonjour@marlone.co
www.marlone.co



Downloads and product information

Product page: <https://marlone.co/produits/gabriel-8124/>